

**RF & MICROWAVE TRANSISTORS**  
**130... 230MHz FM MOBILE APPLICATIONS**

- FREQUENCY 175MHz
- VOLTAGE 12.5V
- POWER OUT 4 → 40W
- HIGH POWER GAIN
- HIGH EFFICIENCY
- FM CLASS C TRANSISTORS
- COMMON EMITTER



**.380 4LSTUD (M135)**  
 epoxy sealed

ORDER CODE	BRANDING
SD1012	2N6080
SD1014-02	2N6081
SD1229-07	2N6082
SD1229-08	2N6083
SD1018	2N6084

**DESCRIPTION**

This line of epitaxial silicon NPN-planar transistor is designed primarily for VHF mobile and marine transmitters. The device utilizes emitter ballasting resistors and improved metallization systems to achieve extreme ruggedness under severe operating conditions.

**PIN CONNECTION**

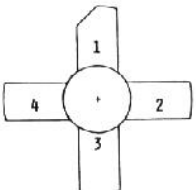

1 collector  
 2 emitter  
 3 base  
 4 emitter

S882N6080-01

**ABSOLUTE MAXIMUM RATINGS (T<sub>A</sub> = 25°C)**

Symbol	Parameter	Value					Unit
		2N6080	2N6081	2N6082	2N6083	2N6084	
V <sub>CBO</sub>	Collector to Base Voltage	36.0	36.0	36.0	36.0	36.0	V
V <sub>CEO</sub>	Collector to Emitter Voltage	18.0	18.0	18.0	18.0	18.0	V
V <sub>EBO</sub>	Emitter to Base Voltage	4.0	4.0	4.0	4.0	4.0	V
I <sub>C(max)</sub>	Continuous Collector Current	1.0	2.5	4.0	4.0	6.0	A
P <sub>D</sub>	Total Dissipation at 25°C Stud	12.0	31.0	65.0	65.0	80.0	W
T <sub>J</sub>	Junction Temperature	+ 200	+ 200	+ 200	+ 200	+ 200	°C
T <sub>stg</sub>	Storage Temperature	- 65 to + 150	- 65 to + 150	- 65 to + 150	- 65 to + 150	- 65 to + 150	°C

**2N6080 → 2N6084**

**THERMAL DATA**

		2N6080	2N6081	2N6082	2N6083	2N6084	
$R_{th(j-c)}$	Junction-case Thermal Resis.	15	5.6	2.8	2.8	2.2	°C/W

**ELECTRICAL CHARACTERISTICS ( $T_{case} = 25^{\circ}C$ )**

**STATIC**

Symbol	Test Conditions	2N6080			2N6081			2N6082			2N6083			2N6084			Unit
		Min.	Typ.	Max.	Min.	Typ.	Max.	Min.	Typ.	Max.	Min.	Typ.	Max.	Min.	Typ.	Max.	
$V_{CES}$	$I_C = 20mA$ $V_{BE} = 0$	36			36			36			36			36			V
$V_{VCE0}$	$I_C = 100mA$ $I_B = 0$	18			18			18			18			18			V
$V_{VEB0}$	$I_E = 10mA$ $I_C = 0$	4			4			4			4			4			V
$I_{CBO}$	$V_{CB} = 15V$ $I_E = 0$			0.25			0.5			1			1			2.5	mA
$h_{FE}$	$V_{CE} = 5V$ $I_E = 0.25A$	5			5			5			5			5			

**DYNAMIC**

Symbol	Test Conditions	2N6080			2N6081			2N6082			2N6083			2N6084			Unit
		Min.	Typ.	Max.	Min.	Typ.	Max.	Min.	Typ.	Max.	Min.	Typ.	Max.	Min.	Typ.	Max.	
$P_O$	$F = 175MHz$ $V_{CE} = 12.5V$ Class C	4			15			25			30			40			W
$G_P$	$F = 175MHz$ $V_{CE} = 12.5V$ Class C	12			6.3			6.2			5.7			4.5			dB
$\eta_C$	$F = 175MHz$ $V_{CE} = 12.5V$ Class C	50			60			50			50			50			%
$F_T$	$V_{CE} = 13.6V$ $I_C = 100mA$ $F = 100MHz$	200			200			200			200			200			MHz
$C_{OB}$	$V_{CE} = 15V$ $I_C = 0$ $F = 1MHz$			20			85			130			130			200	pF

**APPLICATION INFORMATION (typical curves) IMPEDANCE DATA (typical)**

**2N6080**

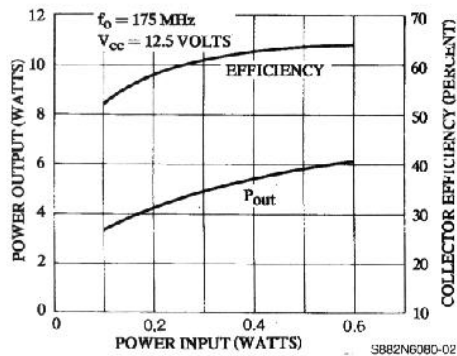

POWER OUT AND EFFICIENCY vs POWER IN

**NETWORK IMPEDANCE AT TRANSISTOR TERMINALS**

$f_o = 175MHz, V_{CC} = 12.5V$			
$P_{IN}$ WATTS	$P_{OUT}$ WATTS	INPUT OHMS	OUTPUT OHMS
0.1	3.3	$1.5 + j1.7$	$5.8 + j1.4$
0.3	4.9	$2.2 + j1.3$	$7.6 + j9.8$
0.5	5.8	$2.9 + j0.4$	$8.4 + j6.9$

2N6081

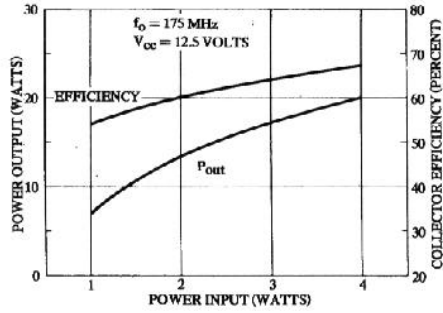

S882N6081-01

POWER OUT AND EFFICIENCY vs POWER IN

NETWORK IMPEDANCE AT TRANSISTOR TERMINALS

$f_0 = 175 \text{ MHz}, V_{CC} = 12.5 \text{ V}$			
$P_{IN}$ WATTS	$P_{OUT}$ WATTS	INPUT OHMS	OUTPUT OHMS
1	9.3	$0.8 - j1.0$	$4.0 + j3.0$
3	19.6	$1.0 - j1.4$	$3.3 + j1.2$
5	27.6	$1.0 - j1.0$	$2.9 + j0.6$

2N6082

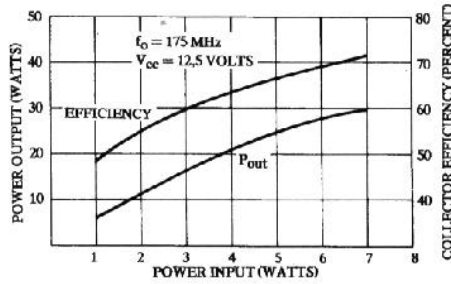

S882N6082-01

POWER OUT AND EFFICIENCY vs POWER IN

NETWORK IMPEDANCE AT TRANSISTOR TERMINALS

$f_0 = 175 \text{ MHz}, V_{CC} = 12.5 \text{ V}$			
$P_{IN}$ WATTS	$P_{OUT}$ WATTS	INPUT OHMS	OUTPUT OHMS
2.5	17.4	$0.8 - j1.0$	$2.4 + j1.5$
5.0	27.5	$0.9 - j0.9$	$2.1 + j0.4$
7.5	35.8	$0.9 - j1.1$	$2.2 + j0.1$

2N6080 → 2N6084

2N6084

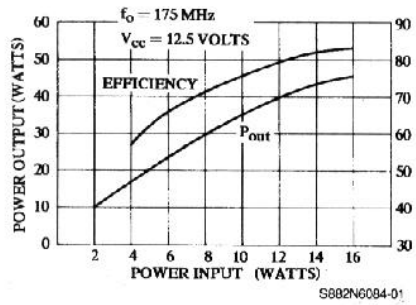

POWER OUT AND EFFICIENCY vs POWER IN

NETWORK IMPEDANCE AT TRANSISTOR TERMINALS

$f_o = 175 \text{ MHz}, V_{cc} = 12.5 \text{ V}$			
$P_{in}$ WATTS	$P_{out}$ WATTS	INPUT OHMS	OUTPUT OHMS
4	21.7	$0.8 - j1.1$	$2.2 - j0.3$
8	37.1	$0.8 - j1.3$	$1.7 - j0.5$
12	46.5	$0.8 - j1.6$	$1.6 - j0.3$

**PACKAGE MECHANICAL DATA**

.380 4LSTUD

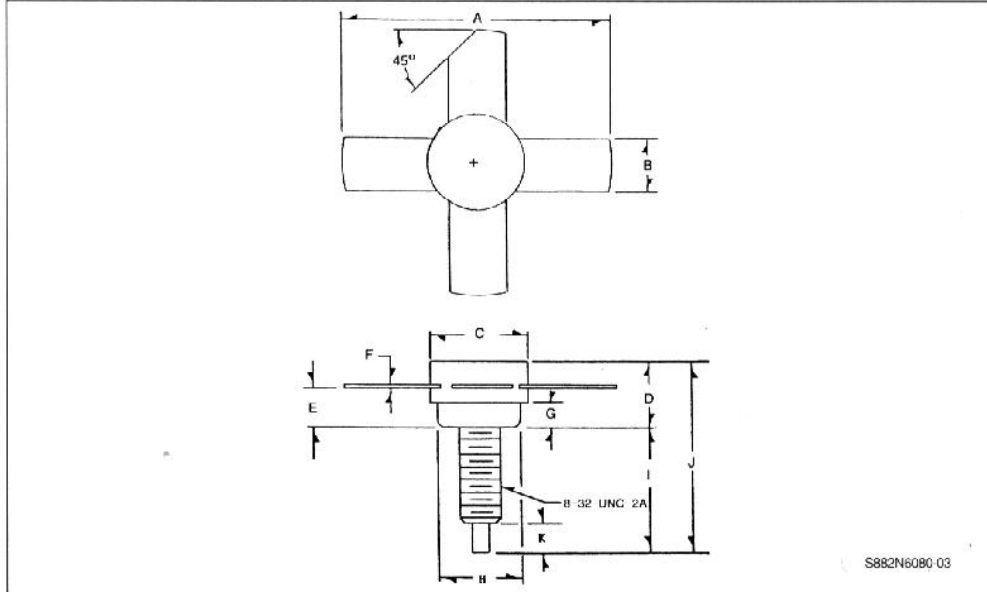

	Minimum Inches	Maximum Inches
A	.980	
B	.220	.230
C	.370	.385
D		.275
E	.155	.175
F	.004	.007

	Minimum Inches	Maximum Inches
G	.090	.100
H	.320	.330
I	.450	.490
J		.750
K	.100	.130